

MOTOR SPECIFICATIONS

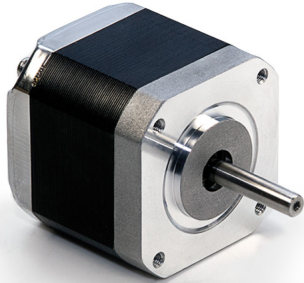

DIMENSIONS

Part Number	WO-4418X-01
Step Angle	1.8°
Frame Size	NEMA 17
Body Length (Dim. A)	1.17 in (29.7 mm)
Current	1.5 Amps/Phase
Holding Torque	37 oz-in (0.26 Nm)
Resistance	1.5 Ohms/Phase
Rotor Inertia	0.21 oz-in ²
Number of Leads	4
Connection	Bipolar
Weight	0.45 lbs (0.20 kg)

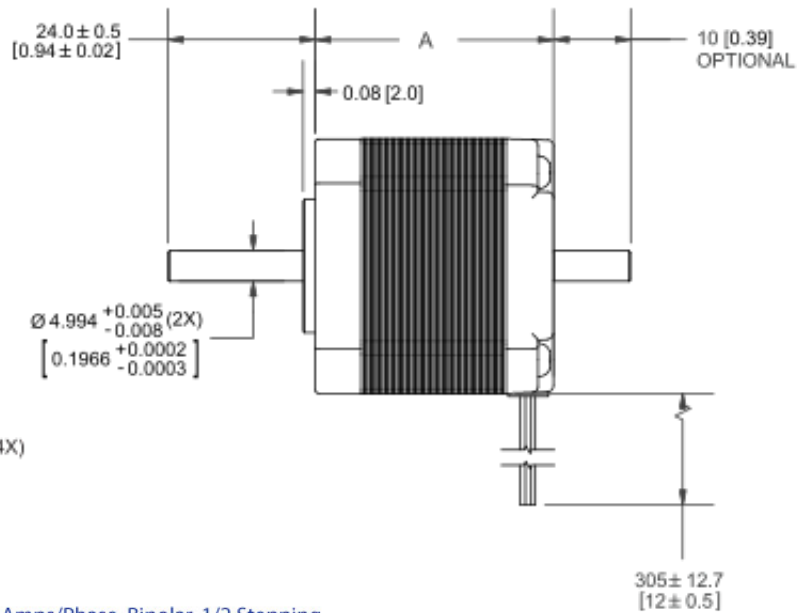
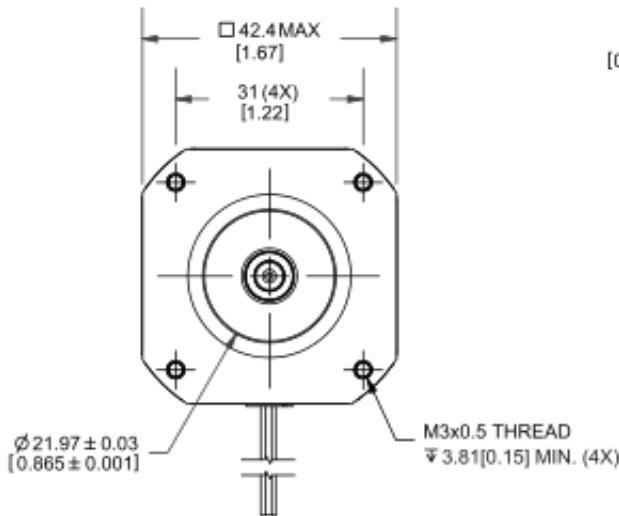

PERFORMANCE CURVE

4418X-01 24VDC, 1.5 Amps/Phase, Bipolar, 1/2 Stepping

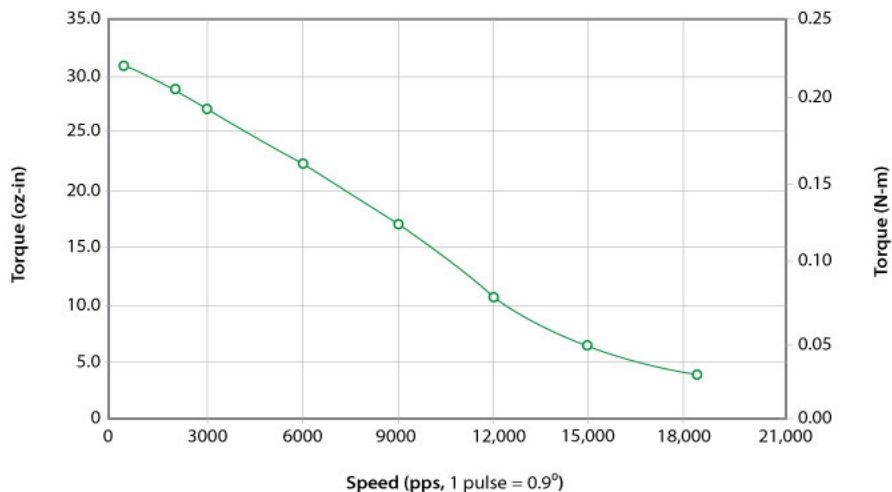

OPERATING SPECIFICATIONS

Radial Play	0.001" max @ 1 lbs load
End Play	0.003" max @ 2 lbs load
Shaft Run Out	0.002" TIR
Concentricity of Mounting Pilot to Shaft	0.003" TIR
Perpendicularity of Shaft to Mounting Face	0.003" TIR
Max Axial Load	6 lbs
Maximum Case Temperature	80 C
Ambient Temperature	-20° to 50° C
Storage Temperature	-20° to 100° C
Humidity Range	85% or less, non-condensing
Magnet Wire Insulation	Class B 130° C
Insulation Resistance	100MΩ at 500 VDC
Dielectric Strength	500 VAC for 1 minute

WIRING TABLE

COLOR	FUNCTION
Red	A+ Phase
Blue	A- Phase
Green	B + Phase
Black	B- Phase

OPERATION & USAGE TIPS

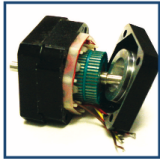

Do not disassemble motors; a significant reduction in motor performance will occur.

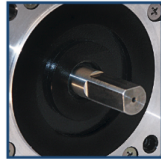

Do not machine shafts; this will have a negative effect on shaft run out and perpendicularity.

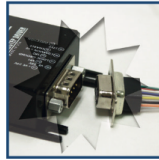

Do not disconnect motor from drive while in operation.

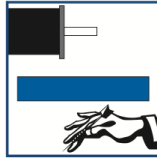

Do not use holding torque/detent torque of motor as a fail safe brake.

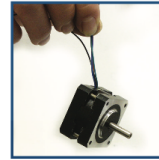

Do not hold motor by lead wires.



Do not exceed the rated current; this will burn the motor.

FAILURE TO COMPLY WITH THESE RECOMMENDATIONS WILL VOID ALL WARRANTY TERMS

RECOMMENDED



Single Axis Driver
R325P



Single Axis Controller+Driver
R356

Motion Control, **Solved.**

MOTOR ENGINEERING & MANUFACTURING



Optimized
For Your
Application



Quick
Prototype
Turnaround



Small Batch
to OEM Volume
Production



US Based
Support &
Manufacturing